



**powerstation<sup>®</sup>**  
**& powerstation XXL**

Made for Apple and USB devices

---

USER MANUAL

## **Welcome**

Thank you for purchasing the mophie® powerstation® or powerstation XXL portable battery with Lightning input connector. Your powerstation or powerstation XXL portable battery is a compact yet powerful mobile charging solution for your Apple devices as well as USB devices. Now you will be able to travel great distances and be the master of your own destiny, no longer bound by the limitations of your device's internal battery!

## **Package contains**

- powerstation or powerstation XXL portable battery with Lightning input connector
- Quick-start guide

## **Features**

Here's a rundown of why your powerstation or powerstation XXL portable battery is so great:

- High-density, high-output universal battery charges devices at fast speeds—up to 2.1 amps.
- Multiple USB output ports let you charge more than one device at a time.
- Lightning input connector uses your Apple device's Lightning cable to recharge the powerstation or powerstation XXL portable battery at fast speeds—up to 2.1A with a compatible wall adapter.

- Priority+® charging provides power to a connected device first before the powerstation or powerstation XXL portable battery starts to recharge – with 2.1A wall adapter or greater.
- Track battery power at a glance with the integrated four-light LED status indicator. You can keep tabs on charging status and current battery life. Know before you go!
- mophie's smart adaptive charging technology identifies your connected device and always delivers the fastest, most efficient charging speeds available.
- Digital Power Management circuitry provides built-in short-circuit, overcharge and temperature protection. Safety first!

## **Compatibility**

The mophie powerstation and powerstation XXL portable batteries are designed to work with most Apple devices as well as popular USB devices and wearables.

- If you experience any issues with charging your device, ensure that the powerstation or powerstation XXL portable battery is fully charged and check the FAQ section on this website.

No matter what device you have, carefully read through the Warning section in this manual and in the quick-start guide included with your battery before using it.

The powerstation and powerstation XXL portable batteries with Lightning input connector require a Lightning cable (not supplied) for recharging.

### **Charging your *powerstation* portable battery**

**IMPORTANT:** Before using your powerstation or powerstation XXL portable battery for the first time, fully charge it (so that pressing the charge status button lights all four status LEDs).

To charge your powerstation or powerstation XXL portable battery, use the Lightning cable included with your Apple device to connect the battery's Lightning input connector to a power source with a USB output, such as the wall adapter included with your Apple device.

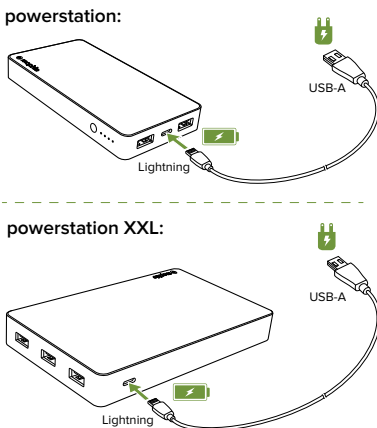

## Charging your device

Connect the cable that came with your device to one of the powerstation or powerstation XXL portable battery's USB-A ports and to your device. All of the USB-A output ports are available simultaneously, so you can charge multiple devices at the same time. Press the status button for 3 seconds to begin charging.

powerstation:

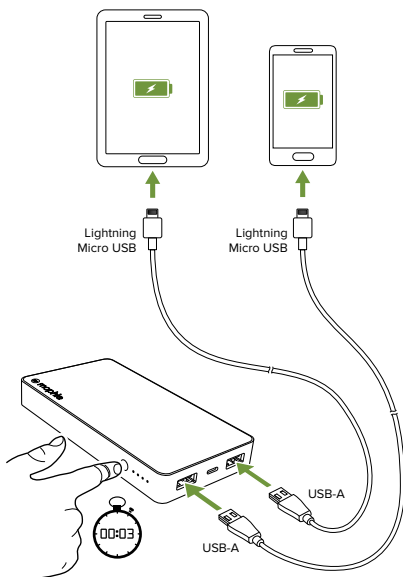

The powerstation XXL portable battery has a total of three USB-A output ports, and can charge up to three devices at the same time. Two of the ports charge at speeds up to 2.1A and one port charges at speeds up to 1.0A. Refer to the illustration below. (The charging speeds are also marked on the underside of the unit.) Press the status button for 3 seconds to begin charging.

powerstation XXL:

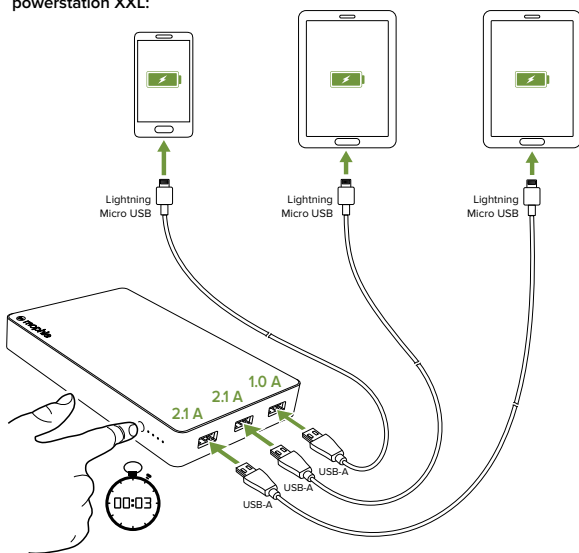

## Priority+ charging

When you're recharging your powerstation or powerstation XXL portbale battery, Priority+ charging provides power to a connected device first before the battery starts to recharge. Priority+ charging is available at the USB port that is marked with the following icon: 

powerstation:

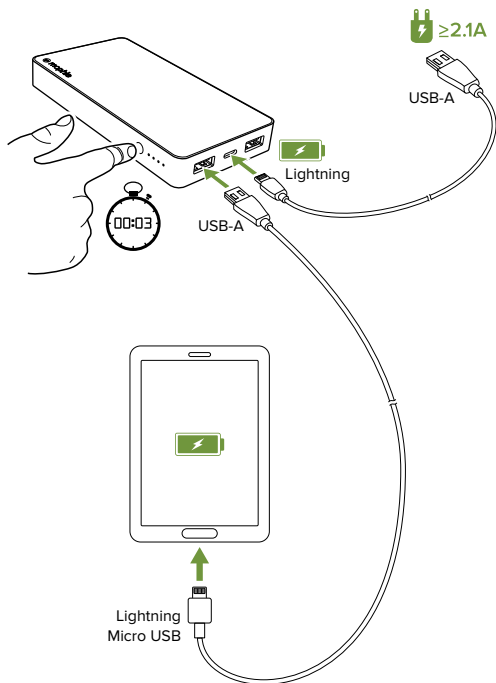

## powerstation XXL:

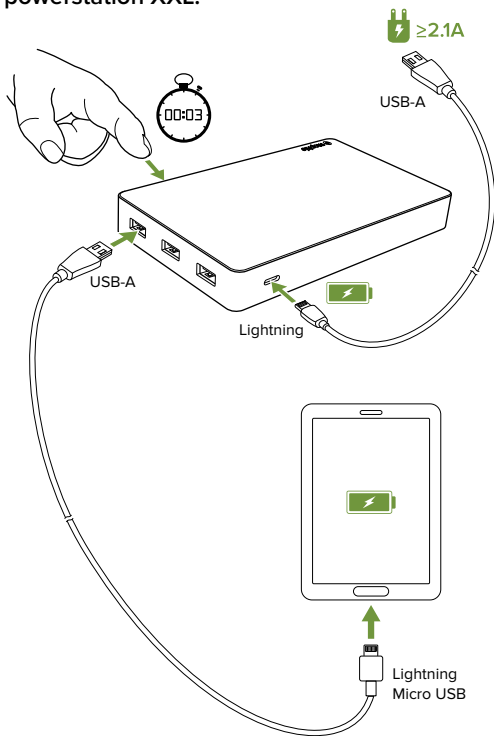



## Checking your battery's charging status

Press the status button on your powerstation or powerstation XXL portable battery and the status LEDs will indicate its charge level. Four LEDs means that the battery is fully charged, while one LED means that it's almost empty. Know before you go!

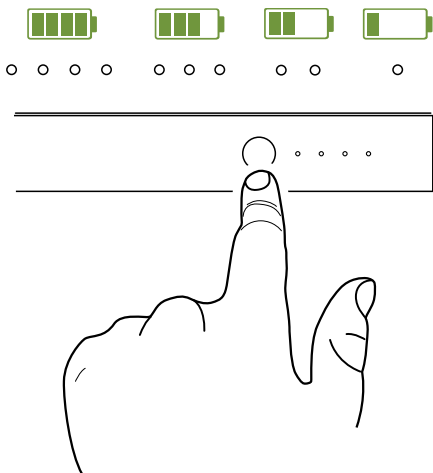

## **Taking care of your *powerstation* portable battery**

- Keep your powerstation or powerstation XXL portable battery dry and away from moisture and corrosive materials.
- Do not clean your powerstation or powerstation XXL portable battery with harsh chemicals, soaps or detergents. Just wipe the case with a soft, water-dampened cloth.
- Make sure the powerstation or powerstation XXL portable battery's charging ports do not become contaminated with lint or other debris. Use a canned-air type of product periodically to ensure that the port openings are clear.
- Recharge your powerstation or powerstation XXL portable battery once every three months when not in use. If you plan on putting it away, fully charge it first (so that pressing the status button lights all four charge status LEDs).

## **Warranty**

At mophie, we are dedicated to making the best quality products. To back this up, this product is warranted for 2 years from date of purchase. For full details regarding warranty terms and exclusions, please visit: [mophie.com/warranty](http://mophie.com/warranty). This warranty does not affect any statutory rights that you may be entitled to. Keep a copy of your purchase receipt as proof of purchase. Be sure to register your product at [mophie.com](http://mophie.com). Failure to register your product and/or provide proof of purchase may void the warranty.

## **Exclusions & limitations**

Except for the limited warranty expressly set forth or to the extent restricted or prohibited by applicable law, mophie expressly disclaims any and all other warranties express or implied, including any warranty of quality, merchantability, or fitness for a particular purpose, and you specifically agree that mophie shall not be liable for any special, incidental, indirect, punitive, or consequential damages of any type on any mophie product. In addition to and without limiting the generality of the foregoing disclaimers, the limited warranty does not, under any circumstances, cover the replacement or cost of any electronic device or personal property inside or outside of the mophie product.

You may have additional warranty rights depending on your country, state or province. Further, some countries, states and provinces do not allow the exclusion or limitation of incidental or consequential damages or exclusions or limitations on the duration of implied warranties, so the above may not apply to you. If any provision of the warranty is found unlawful, void or unenforceable, that provision shall be deemed severable and shall not affect any remaining provision.

## Customer service

Telephone: 1-888-8mophie [1-888-866-7443]

International: +1 (269) 743-1340

Web: [www.mophie.com/cs](http://www.mophie.com/cs)

## Warning

Read all instructions and warnings prior to using this product. Improper use of this product may result in product damage, excess heat, toxic fumes, fire or explosion, for which damages you ("Purchaser"), and not mophie llc ("Manufacturer") are responsible.

- ⓧ Before using your powerstation or powerstation XXL portable battery for the first time, fully charge it (so that pressing the charge status button lights all 4 of the status LEDs).
- ⓧ Do not store device in high-temperature environment, including heat caused by intense sunlight or other forms of heat. Do not place device in fire or other excessively hot environments.
- ⓧ The powerstation and powerstation XXL portable batteries should be operated only in open-air conditions. They should not be operated in an enclosed, unventilated space such as a carrying bag, pocket, purse, or bedding. Failure to follow these instructions may cause damage to the battery by overheating.
- ⓧ Be cautious of drops, bumps, abrasions, or other impacts to this device. If there is any damage

to the device such as dents, punctures, tears, deformities, or corrosion due to any cause, discontinue use. Contact Manufacturer or dispose of it in an appropriate manner at your local battery-recycling center.

 Do not disassemble this device or attempt to re-purpose or modify it in any manner.

 Do not attempt to charge this device using any method, apparatus, or connection other than the device's Lightning input port. For questions or instructions for the ways to charge the device refer to the illustrations in the *Charging your powerstation portable battery* section of this user manual.

 Do not attempt to replace any part of this device.

 If this device is accessible to or may be used by a minor, purchasing adult agrees to be solely responsible for providing supervision, instruction, and warnings. Purchaser agrees to defend, indemnify, and hold Manufacturer harmless for any claims or damages arising from unintended use or misuse by a minor.

 All products have gone through a thorough quality assurance inspection. If you find that your device is excessively hot, is emitting odor, is deformed, abraded, cut or is experiencing or demonstrating an abnormal phenomenon, immediately stop all product use and contact Manufacturer.

- ⓧ Never dispose of batteries in the garbage. Disposal of batteries in the garbage is unlawful under state and federal environmental laws and regulations. Always take used batteries to your local battery-recycling center.

## **Legal**

This product is meant for use only in conjunction with the appropriate device. Please consult your device packaging to determine whether this product is compatible with your particular device. Manufacturer is not responsible for any damages to any device incurred through the use of this product.

Manufacturer shall not in any way be liable to you or to any third party for any damages you or any third party may suffer as a result of use, intended or unintended, or misuse of this product in conjunction with any device or accessory other than the appropriate device for which this product is designed. Manufacturer will not be responsible for any damages you or any third party may suffer as a result of misuse of this product as outlined above. Purchaser agrees to defend, indemnify, and hold Manufacturer harmless for any claims or damages arising from unintended use or misuse, including use with an unintended device.

mophie, powerstation, Power for all, Priority+, Stay Powerful, the five-circles design, and the mophie logo are trademarks of mophie inc. Apple and Lightning are trademarks of Apple Inc. Use of the Made for Apple badge means that an accessory has been designed to connect specifically to the Apple product(s) identified in the badge, and has been certified by the developer to meet Apple performance standards. Apple is not responsible for the operation of this device or its compliance with safety and regulatory standards. Please note that the use of this accessory with an Apple product may affect wireless performance. IOS is a trademark or registered trademark of Cisco in the U.S. and other countries and is used under license. All rights reserved. Patents: [mophie.com/patents](http://mophie.com/patents).

This device complies with part 15 of the FCC Rules and RSS-Gen of IC Rules. Operation is subject to the following two conditions: (1) This device may not cause harmful interference, and (2) this device must accept any interference received, including interference that may cause undesired operation.

NOTE: This equipment has been tested and found to comply with the limits for a Class B digital device, pursuant to part 15 of the FCC Rules. These limits are designed to provide reasonable protection against harmful interference in a residential installation. This

equipment generates, uses, and can radiate radio frequency energy and, if not installed and used in accordance with the instructions, may cause harmful interference to radio communications. However, there is no guarantee that interference will not occur in a particular installation.

If this equipment does cause harmful interference to radio or television reception, which can be determined by turning the equipment off and on, the user is encouraged to try to correct the interference by one or more of the following measures:

- Reorient or relocate the receiving antenna.
- Increase the separation between the equipment and receiver.
- Connect the equipment into an outlet on a circuit different from that to which the receiver is connected.
- Consult the dealer or an experienced technician for help.

**CAUTION:** To comply with the limits of the Class B digital device, pursuant to Part 15 of the FCC Rules, this device must be used with certified peripherals and shielded cables. All peripherals must be shielded and grounded. Operation with non-certified peripherals or non-shielded cables may result in interference to radio or reception.



MODIFICATION: Any changes or modifications of this device could void the warranty.

### **WEEE Declaration**

All of our products are marked with the WEEE symbol; this indicates that this product must NOT be disposed of with other waste. Instead it is the user's responsibility to dispose of their waste electrical and electronic equipment by handing it over to an approved re-processor, or by returning it to mophie inc. for reprocessing. For more information about where you can send your waste equipment for recycling, please contact mophie inc. or one of your local distributors.

 STAY POWERFUL<sup>®</sup>